

Explosion Proof Light

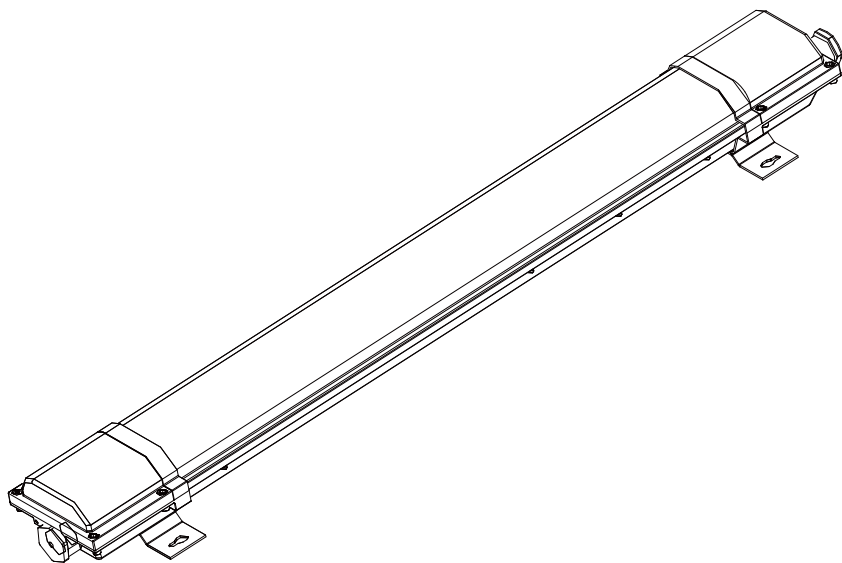

MANUAL DE USUARIO / USER MANUAL
MANUEL DE L'UTILISATEUR / BEDIENUNGSANLEITUNG
MANUALE UTENTE / MANUAL DE USUÁRIO

WARNING

Before carrying out any manipulation, make sure to disconnect the luminaire from the power supply. Any incidents in the installation haven't made in accordance with this installation guide will be the responsibility of the installer. Replacement or maintenance of any component must be supplied or recommended by the manufacturer. The light source of this luminaire should be replaced only by the manufacturer, its service or equivalent qualified person.

ADVERTENCIA

Antes de proceder a cualquier manipulación, debe asegurarse de desconectar la luminaria de la alimentación eléctrica. Cualquier incidencia en la instalación que no se haya realizado de acuerdo con esta guía de instalación será responsabilidad del instalador. La fuente de luz de esta luminaria debe reemplazarse únicamente por el fabricante, su servicio técnico o persona cualificada equivalente. La reposición o mantenimiento de cualquier componente deberá ser suministrado o recomendado por el propio fabricante.

ATTENTION

Avant de manipuler, assurez-vous de débrancher l'appareil de l'alimentation électrique. Toute manipulation sur l'installation qui n'a pas été réalisée selon ce guide d'installation est la responsabilité de l'installateur. Le remplacement de tous les composants doivent être fournis ou recommandés par le fabricant. La source lumineuse de ce luminaire ne doit être remplacée que par le fabricant, son service ou sa personne qualifiée équivalente.

WARNUNG

Vor jeder Manipulation, stellen Sie sicher, dass die Leuchte von der Stromversorgung zu trennen. Alle Auswirkungen auf die Installation, die nicht wurde gemäß dieser Installationsanleitung durchgeführt ist die Verantwortung des Installateurs. Der Austausch oder die Wartung von Komponenten muß vom Hersteller geliefert oder empfohlen werden. Die Lichtquelle dieser Leuchte sollte nur durch den Hersteller, seinen Service oder eine gleichwertige qualifizierte Person ersetzt werden.

ATTENZIONE

Prima di qualsiasi manipolazione, assicurarsi di scollegare l'apparecchio dalla rete elettrica. Ogni impatto sulla installazione che non è stata eseguita in base a questa guida di installazione è la responsabilità dell'installatore. Sostituzione o manutenzione di qualsiasi componente devono essere forniti o raccomandati dal fabbricante. La sorgente luminosa di questo apparecchio deve essere sostituita solo dal costruttore, dal suo servizio o da personale qualificato equivalente.

AVISO

Antes de qualquer manipulação, certifique-se de desligar a luminária da fonte de alimentação. Qualquer impacto sobre a instalação que não foi realizada de acordo com este manual de instalação é de responsabilidade do instalador. Substituição ou manutenção de qualquer componente deve ser fornecido ou recomendado pelo fabricante. A fonte luminosa desta luminária deve ser substituída apenas pelo fabricante, pelo seu serviço ou por uma pessoa qualificada.

Explosion Proof Light

WARNING

Connection block included. Installation of the luminaire may require the intervention of a qualified person.



PHOTOBIOLOGICAL RISK

The luminaire shall be so placed that a prolonged look at the luminaire don't expected at a distance closer to 2,8 meters.

- This luminaire is designed to be installed in exteriors and interiors of industrial zones, ships, factories, etc.
- Luminaire configurations are designed to operate at a maximum ambient temperatures of t_a 35°C.
- Luminaire is designed to be mounted horizontally with the LEDs facing downwards as shown in the image.

APPLICATION

Applied to oil fields, oil refineries, offshore oil platform, power plants, gas stations, oil tanks, wharf, tunnel, pumping station, substation, the military base, etc. Zone and Zone 2 Hazardous Locations, Zone 21, Zone 22 and II A, IIB, IIC explosive gas and dust atmosphere.

CONFORMITY WITH STANDARDS

The product complies with the ATEX Directive 94/9 EC and standards:

- EN 60079-0: 2013
- EN 60079-7: 2015
- EN 60079-18: 2015
- EN 60079-31: 2014

The product is developed, manufactured and tested according to EN/ISO 9001: 2015

The product is in compliance with:

- LVD Directive 2014/35 EU
- EMC Directive 2014/30 EU
- RoHS Directive 2011/65 EU

SPECIFICATIONS

Electrical Power (W): From 20W to 75W

Voltage (V): 220~240V

Power Factor: 0,95

IP protection: 66

IK protection: 10

Electrical power class: Class 1

N.W / G.W: Dimensions (LxWxH):

0.6M 20W: 3.3Kg / 4.0Kg & 599*114*69mm

0.6M 40W: 3.3Kg / 4.0Kg & 599*114*69mm

1.2M 40W: 4.2Kg / 5.0Kg & 1199*114*69mm

1.2M 60W: 4.2Kg / 5.0Kg & 1199*114*69mm

1.2M 75W: 4.2Kg / 5.0Kg & 1199*114*69mm

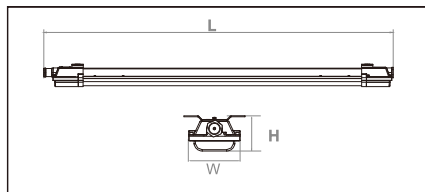

EXPLOSION PROTECTION



II 2G Ex eb mb IIC T6 Gb
II 2D Ex tb IIC T(110°C) Db

INSTALLATION

1. UNPACKAGING

Unpack the luminaire and check that any part hasn't been damaged. If it finds any damage, keep the luminaire back in the packaging and contact us.

2. HANDLING

If the luminaire is handled incorrectly after removal from the packaging, damage may occur. Don't knock or stack luminaires after removing them from the packaging.

3. INSTALLATION

A) Recessed mounting:

- Install the ceiling bracket on the lamp body and tighten the screws



- Fix the lamp to the wall or ceiling

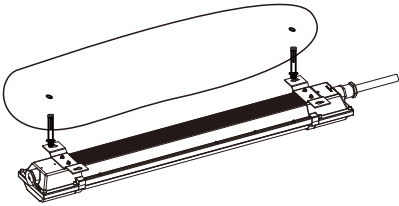

- If the installation is correct, the luminaire should be fixed as the image below

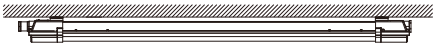

B) Bracket mounting:

⚠ WARNING

For this type of installation you will need a bracket kit

- Install the rotating bracket on the lamp body and tighten the screws



- Fix the lamp to the wall or ceiling

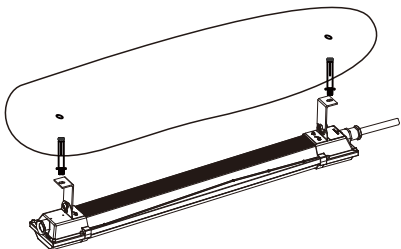

- Fix the lamp and then connect wire

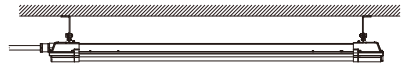

4. WIRING

- Check that the supply voltage is correct and connect the power cables of the luminaire following the color code as shown in the indications.

⚠ WARNING

The flexible cable or outside cord of this luminaire can't be replaced. If the cable is damaged, the luminaire must be destroyed.

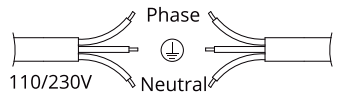

Connections

Cable colour:	Supply type:
Brown/Black	Phase
Yellow&Green/Green	Ground ⊕
Blue/White	Neutral

- Make sure that the cable connection is correct. If the installation is correct, the luminaire should be fixed as in the image below



5. MAINTENANCE / CLEANING

To maintain the high efficiency of the high bay, it needs occasional cleaning on the lens surface. Use a soap with neutral pH with a cloth to clean and dry it.